

Horizontal Fiber Optic Splice Closure - Inline(FOSC)

B1-OPCL12P64



Installation Manual



1. Scope of application

This Installation Manual is suit for the Fiber Optic Splice Closure (Hereafter abbreviated as FOSC), as the guidance of proper installation.

The scope of application is: aerial, underground, wall-mounting, wall-mounting in duct and handhole. The ambient temperature ranges from -40 to +65°C.

2. Basic structure and configuration

2.1 Dimension and capacity

Outside dimension (LxWxH)	400x185x90(mm)
Weight (excluding outside box)	1900g-2100g
Number of inlet/outlet ports	6 ports
Diameter of fiber cable	Φ 8—Φ 16(mm)
Capacity of FOSC	Bunchy: 6—96(Cores) Ribbon: max. 144 (Cores)

2.2 Main components

No.	Name of components	Quantity	Usage	Remarks
1	Housing	1 set	Protecting fiber cable splices in whole	Internal diameter: 285x110 (mm)
2	Insert plate	2 pairs	Fixing the housing	175x56x30(mm)
3	Fiber optic splice tray (FOST)	Max. 4 trays (bunchy) Max. 4 trays (ribbon)	Fixing heat shrinkable protective sleeve and holding fibers	Suitable for: Bunchy: 6,8,12,16,24(cores) Ribbon: 3 (pieces)
4	Foundation	1 set	Fixing fiber cable, reinforced core and FOST	
5	Seal fitting	1 set	Sealing between FOSC cover and FOSC bottom	
6	Port plug	6 pieces	Sealing empty ports	
7	Earthing deriving device	1 set	Deriving metallic parts of fiber cables in FOSC for earthing connection	Configuration as per requirement





2.3 Main accessories and special tools

No.	Name of accessories	Quantity	Usage	Remarks
1	Heat shrinkable protective sleeve		Protecting fiber splices	Configuration as per capacity
2	Nylon tie		Fixing fiber with protective coat	Configuration as per capacity
3	Insulation tape	1 roll	Enlarging diameter of fiber cable for easy fixing	
4	Seal tape	1 roll	Enlarging diameter of fiber cable which fits in with seal fitting	Configuration as per specification
5	Hanging hook	1 set	For aerial use	
6	Earthing wire	1 piece	Putting through between earthing devices	To put through as per actual requirement
7	Abrasive cloth	1 piece	Scratching fiber cable	
8	Labeling paper	1 piece	Labeling fiber	
9	Special wrench	3 pieces	Fixing bolts, tightening nut of reinforced core	
10	Measuring paper	1 piece	To measure perimeter of fiber cable, of which the diameter is enlarged with seal tape	To measure perimeter with the corresponding measuring paper
11	Buffer tube	To be decided by customers	Hitched to fibers and fixed with FOST, managing buffer	Configuration as per requirement
12	Desiccant	1 bag	Put into FOOSC before sealing for desiccating air.	

3. Necessary tools for installation

3.1 Supplementary materials (to be provided by operator)

Name of materials	Usage
Scotch tape	Labeling, temporarily fixing
Ethyl alcohol	Cleaning
Gauze	Cleaning





3.2 Special tools (to be provided by operator)

Name of tools	Usage
Fiber cutter	Cutting off fibers
Fiber stripper	Strip off protective coat of fiber cable
Combo tools	Assembling FOOSC

3.3 Universal tools (to be provided by operator)

Name of tools	Usage and specification
Band tape	Measuring fiber cable
Pipe cutter	Cutting fiber cable
Electrical cutter	Take off protective coat of fiber cable
Combination pliers	Cutting off reinforced core
Screwdriver	Crossing/Paralleling screwdriver
Scissor	
Waterproof cover	Waterproof, dustproof
Metal wrench	Tightening nut of reinforced core

3.4 Splicing and testing instruments (to be provided by operator)

Name of instruments	Usage and specification
Fusion Splicing Machine	Fiber splicing
OTDR	Splicing testing
Provisional splicing tools	Provisional testing

Notice: The above-mentioned tools and testing instruments should be provided by the operators themselves.





4. Installation flow chart

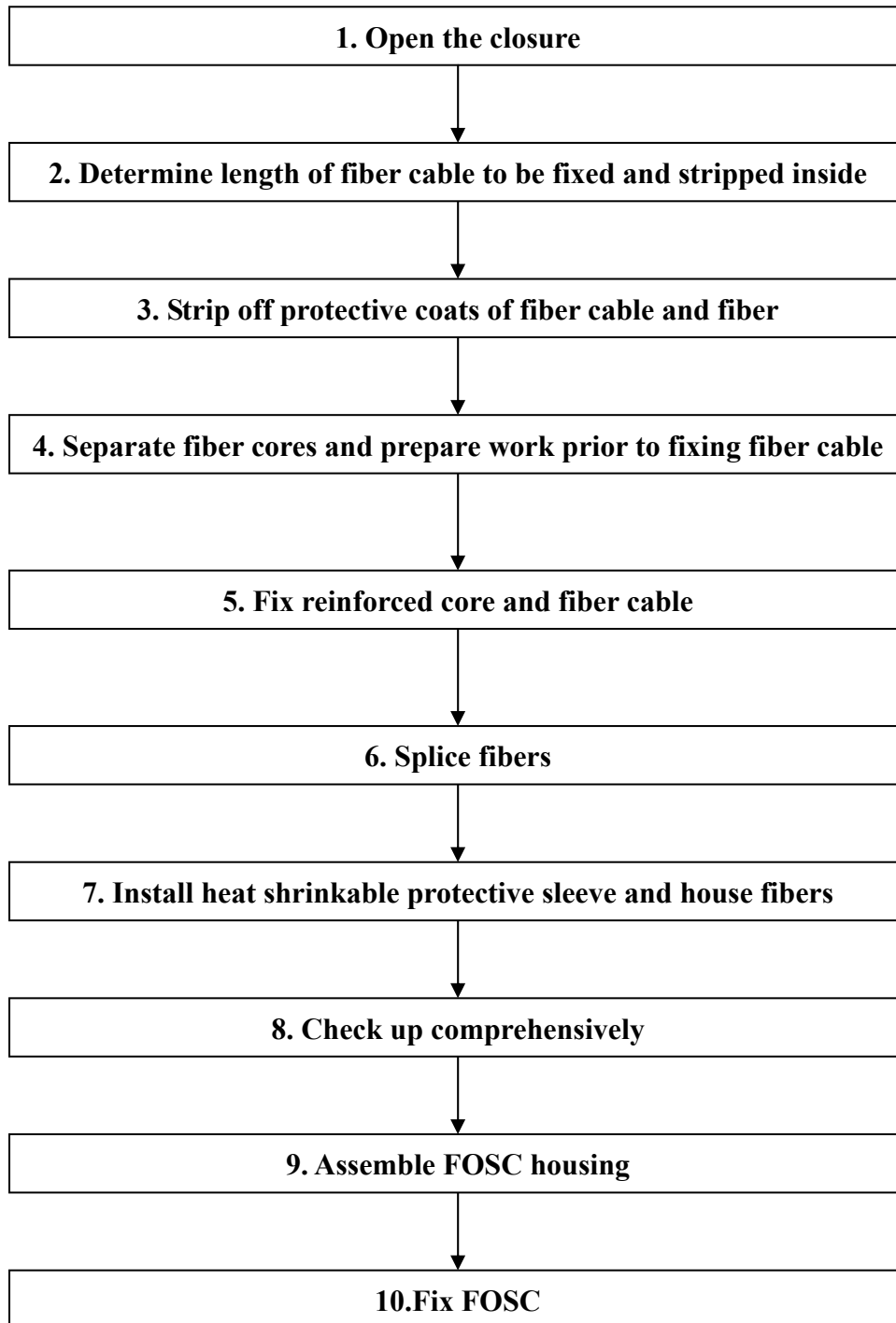



5. The process of installing FOSC

Step One - Open the closure

Cleaning the locale and determine where to install the FOSC and then place fiber cables required.

Check whether the main components and accessories have been well prepared inside the package.

Open the closure

- ① Demount the fixing bolt of insert plate with a special wrench. Put the fixing bolt into the hole with screw thread next to the fixing hole of the insert plate and push the insert plates out with the wrench.
- ② Use the special wrench to demount all the locating bolts on the housing as well as fixing bolts (it is also possible to install hanging hook according to the installation requirement) at four corners, then succeed in opening the closure.

See Drawing 1

Important issues: If the weather condition is not good enough, then a tent must be pitched for waterproof and dustproof.

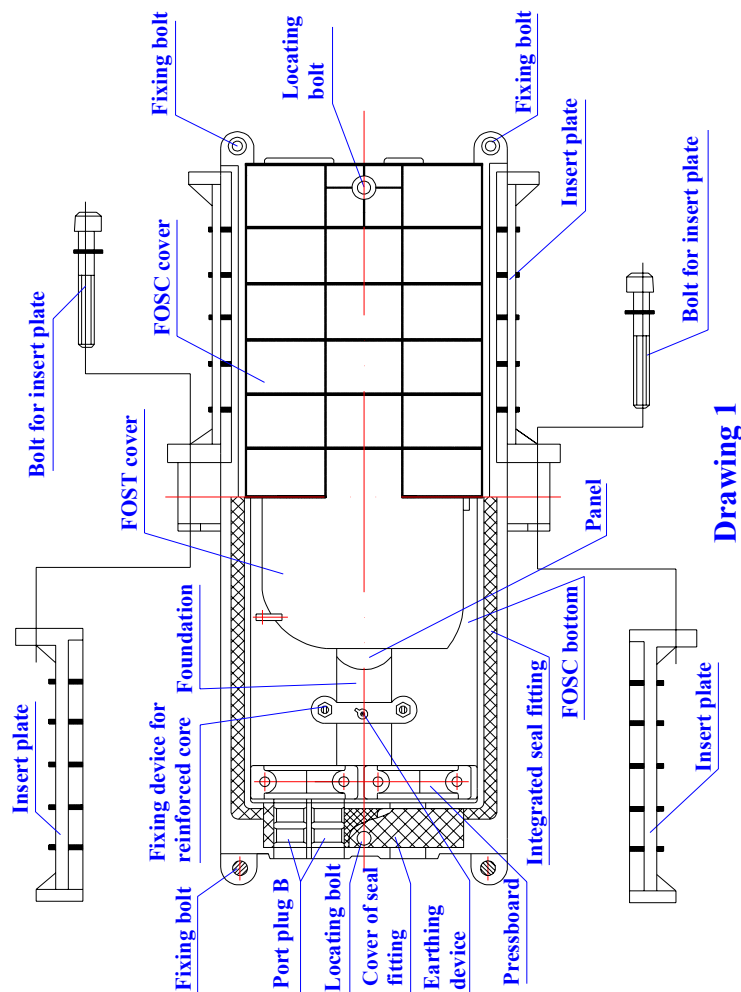



5.2 Step Two -Determine length of fiber cable to be fixed and stripped inside FOSC

- 5.2.1
- ①. Fiber cable in 60mm length: the distance from seal fitting to fiber cable pressboard
 - ②. Fiber cable in 1950mm length: it is used to be wound and spliced after stripping.
 - ③. Fiber with protective coat in 350mm length: the distance from the fixing point of fiber cable to the fixing point of FOST (fiber optic splice tray).
 - ④. Fiber in 1600mm length: after stripping off the protective coat, it is to be wound inside the FOST after splicing with other fibers

5.2.2 See Drawing 2

Important issues:

1. Reserve enough length of fiber cable to be spliced.
2. Stripping length also could be decided by customer according to installation requirement.

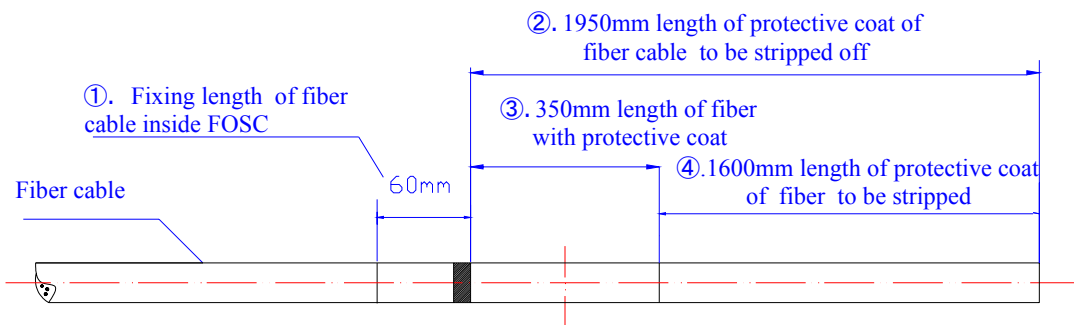

Drawing 2

5.3 Step Three – Strip off fiber protective coat of fiber cable and fiber

5.3.1 Strip off protective coat of fiber cable from the temp. locating mark with the cutter and the stripper, please refer to Drawing 2 for stripping length. Stripping length also could be decided according to installation requirement

5.3.2 See Drawing 3.

Important issues: If it is difficult to pull all the protective coat of fiber cable at one time, strip it off section by section to avoid fiber breakage.

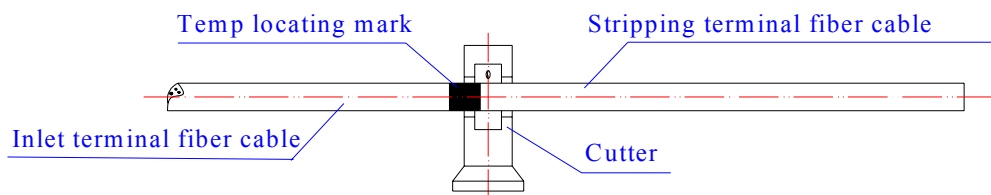

Drawing 3

5.4 Step Four – Separate fiber cores and prepare work prior to fixing fiber.

5.4.1 Wind 2 layers of insulation tape on protective coat of fiber core. Meanwhile, get rid of the stuffing to separate fiber core and clean them. Form a ring with the diameter of 100mm or so and fix it on the fiber temporarily by adhesive tape.



- 5.4.2 This FOSC is provided with 6 inlet/outlet ports. The inlet/outlet ports could be decided according to number and diameters of fiber cables to be actually installed, then the corresponding number of port plugs should be taken out.
- 5.4.3 This FOSC is suitable for the following diameters of fiber cables respectively:
 Port A: suitable for fiber cable with max. diameter $\phi 16\text{mm}$
 Port B: suitable for fiber cable with max. diameter $\phi 13\text{mm}$
- 5.4.4 The corresponding inlet/outlet ports are to be selected according to fiber cables actually installed. When the diameter of fiber cable is smaller than that of the inlet/outlet port, then the seal tape should be used to enlarge the diameter of fiber cable, of which the perimeter could be measured by the corresponding measuring paper (marked with Hole A, Hole B).
- 5.4.5 Reserve reinforced core in 35mm length and cut off the unnecessary ones.
- 5.4.6 See Drawing 4

Important Issues:

1. Before the seal tape is used for enlarging the fiber cable diameter, it should be scratched and to be cleaned with abrasive cloth and ethyl alcohol.
2. Cut off reinforced core with a special cutting plier.

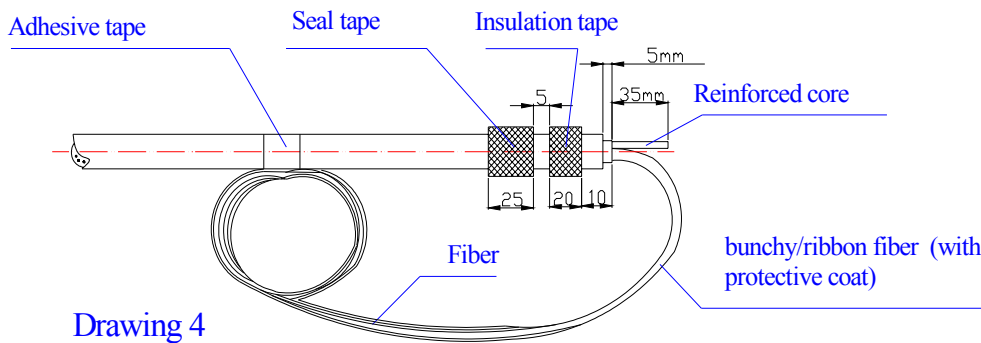

5.5 Step Five - Fix reinforced core and fiber cable

- 5.5.1 Upon finishing the above steps, then demount port plugs, pressboard and fixing nut of reinforced core. Make sure to check whether the fiber cable stripped fits in with the fixing ports or not. If not, the adjustment should be done in time. Otherwise it will affect installation quality.
- 5.5.2 Tighten fiber cable pressboard. If the diameter of fiber cable is small, then enlarge it with insulation tape.
- 5.5.3 Tighten nut of reinforced core with the special wrench (plastic) and then retighten it with the metal wrench (the metal wrench should be provided by operator).
- 5.5.4 See Drawing 5

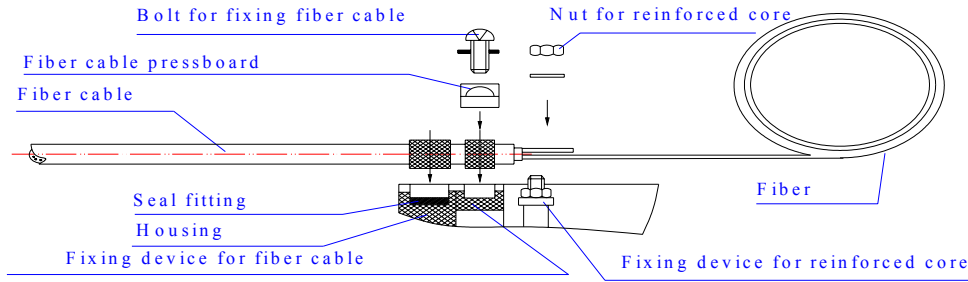

Drawing 5

5.6 Step Six - Splice fibers

5.6.1 Follow user manual of fusion splicing machine to splice fiber.

Important issue: pay attention to the twist and bend of fiber.

5.7 Step Seven -Install heat shrinkable protective sleeve and house fibers

5.7.1 When having completed splicing the fibers, the first fiber ring should be housed on the farthest side of FOST, the remaining fiber should be wound, forming a ring with diameter not less than 80mm. then put it into FOST (Fiber Optic Splice Tray) together with heat shrinkable protective sleeve.(Firstly fix heat shrinkable protective sleeve into the slot, then enlarge the diameter of fiber ring properly.)

5.7.2 See Drawing 6

Important issue: pay attention to the twist and bend of fiber.

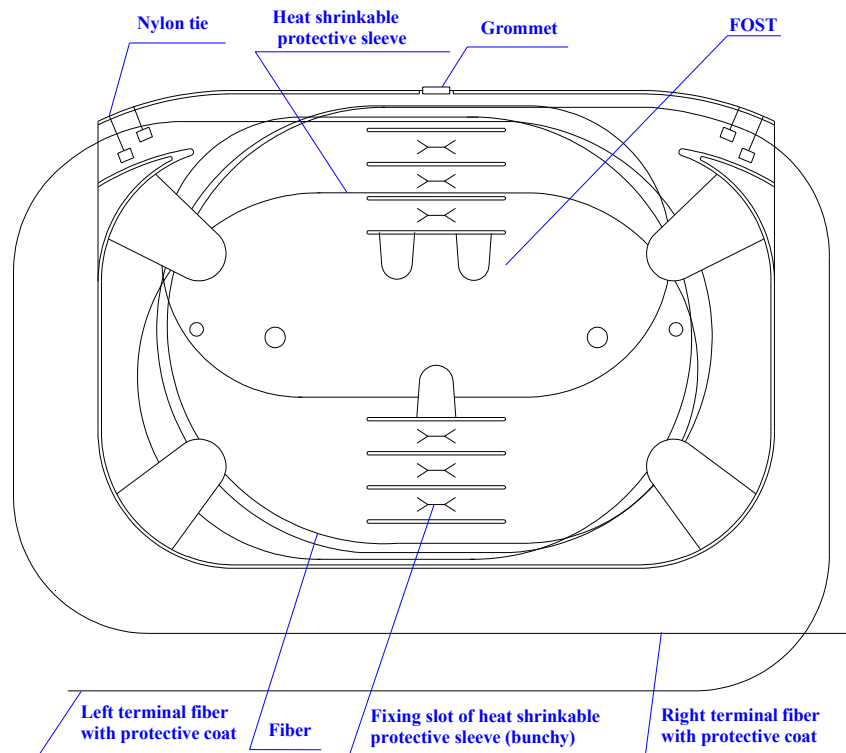

Drawing 6

5.8 Step Eight - Check up comprehensively

To ensure the technical requirements, the following instructions must be followed:

- 5.8.1 The fibers in the FOST are spliced and installed orderly. The curved diameter of fiber meets with the technical requirements.
- 5.8.2 The internal tighteners are tightened.
- 5.8.3 The inlet/outlet ports without fiber cables installed must be blocked up with the port plugs.
- 5.8.4 Control the amount of seal tape within a proper range.
- 5.8.5 Seal fitting is installed neatly and smoothly. If not, level it up with seal tape.
- 5.8.6 Seal the cover of seal fitting
- 5.8.7 See Drawing 7

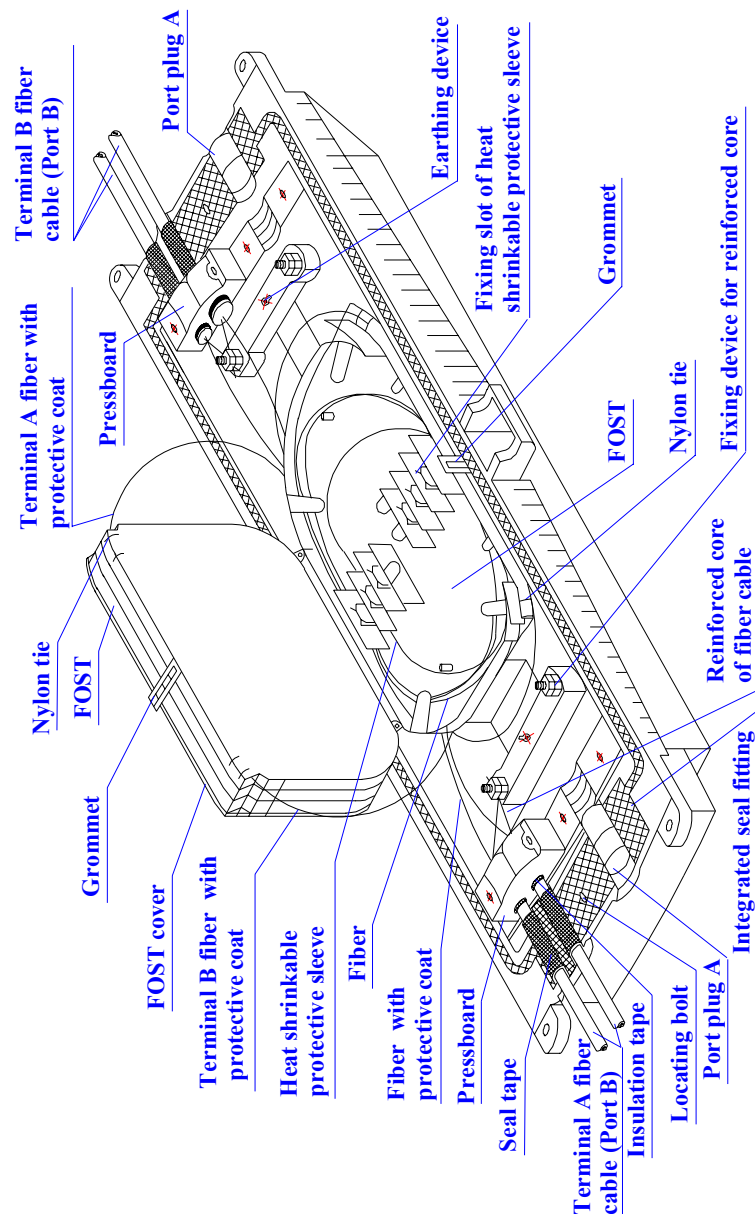

Drawing 7

5.9 Step Nine – Assemble FOSC housing

- 5.9.1 Put the FOSC cover on the FOSC bottom directly.
- 5.9.2 Insert locating bolt of FOSC and tighten it with the special wrench.
- 5.9.3 Put the insert plates into the slot (one pair on each side, one piece with a hole with screw thread in the middle, the other with a hole without screw thread in the middle). Tighten bolts of insert plate with the special wrench .
- 5.9.4 If the FOSC is for aerial application, then put the hanging hook on one side of the closure and then tighten fixing bolts on both sides. Otherwise tighten the 4 fixing bolts at four corners respectively.
- 5.9.5 See drawing 8

Important issues: cleaning the housing and pay attention to the above sequence.

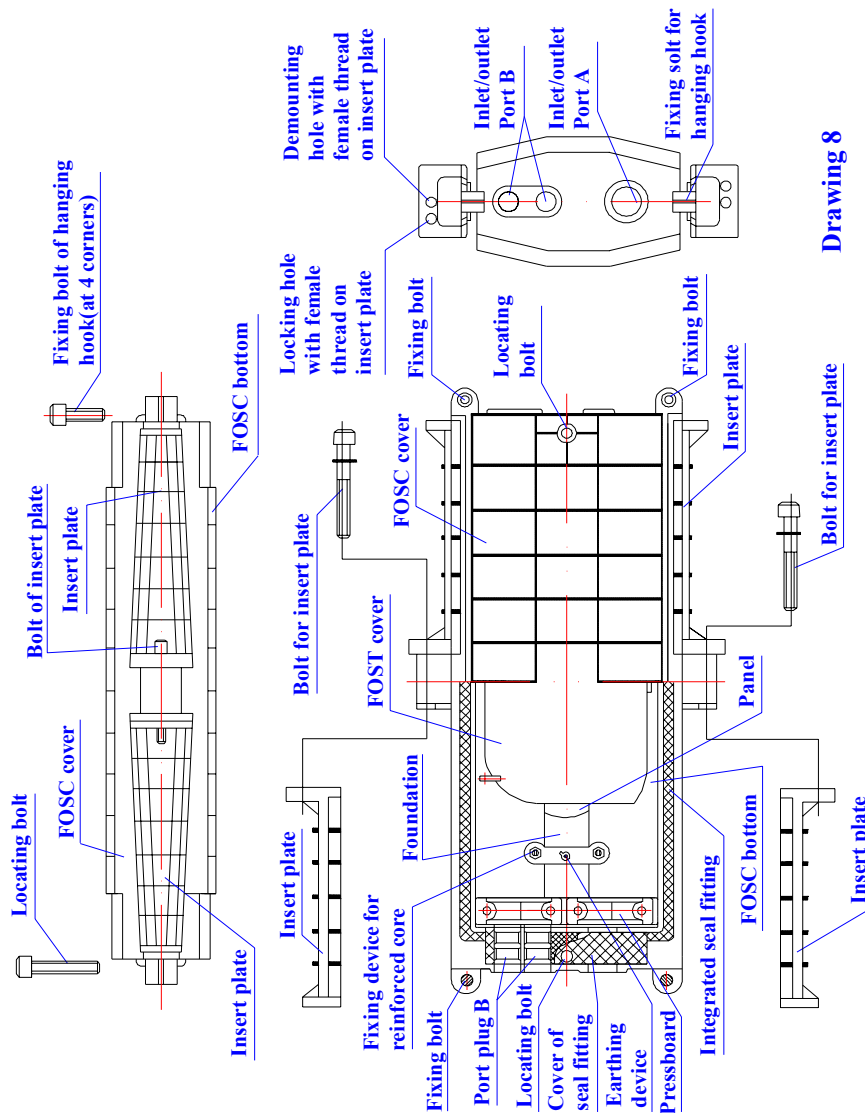

Drawing 8



5.10 Step Ten - Fix FOSC .

5.10.1 Fixing the FOSC and tighten bolts in sequence as per drawing 9.

Important issues: Retighten in five minutes

Tighten properly to avoid the closure to be out of shape.

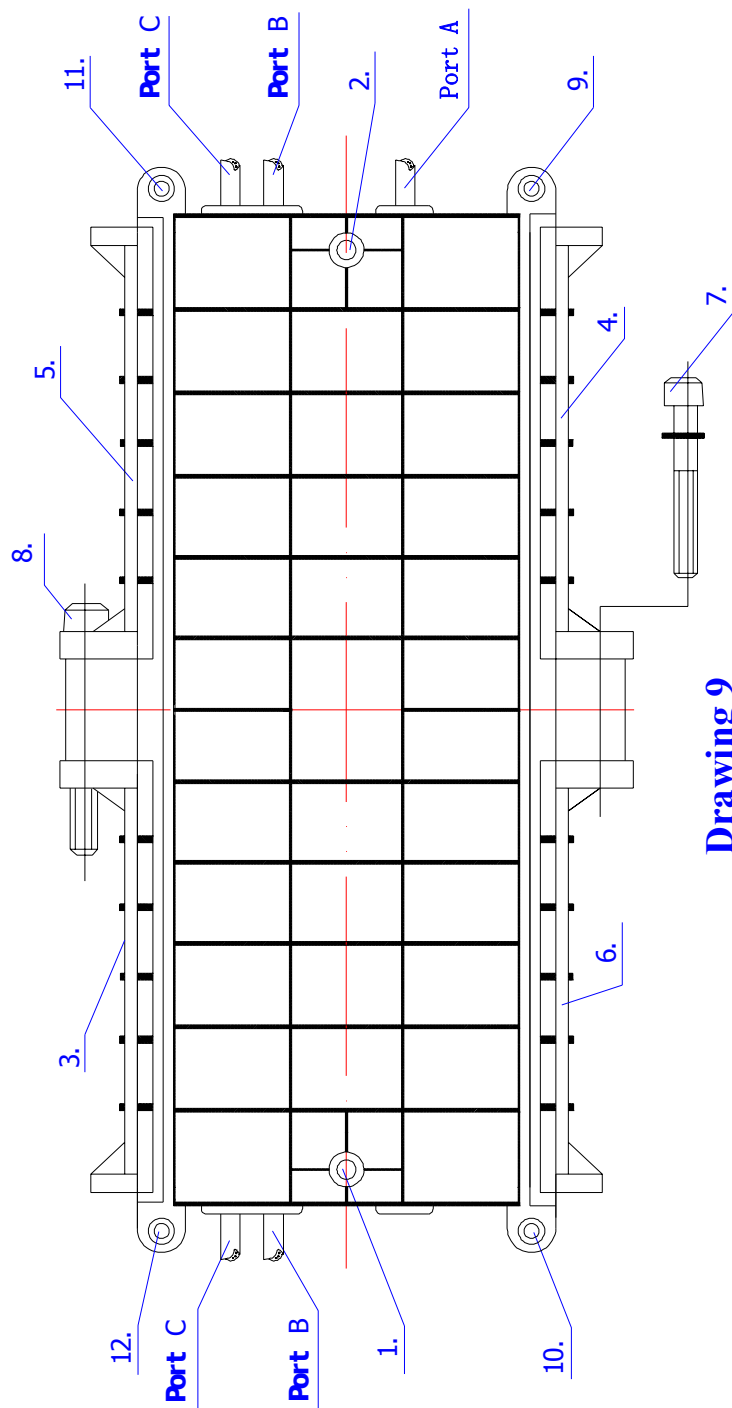



6. Fiber Optic Splice Closures (FOSC) inspecting and testing items

Inspecting item	Technical Requirements	Inspecting type	
		Routine test (Before leaving factory)	Type test
Package	Each small package contains one fiber optic splice closure, together with its accessories, tools, installation manual and packing list.	full	At least 3 sets sampled each time
Appearance	Intact in shape, no burrs, bubbles, chaps, pores, warps, impurities and other defects, all background colors should be even and continual.		
Sign	There is a clear sign on the housing, such as name and model of the product, etc.		
Fiber storage device	The fibers reserved are to be winded in fiber optic splice tray (FOST), the length of fibers housed in FOST is >1.6m, the curved radius is >30mm. During the installation and maintenance, there should be no attenuation on fibers.	At least 3 sets sampled each time	
Electrical jointing device	Inside FOOSC: metallic components of fiber cables has the functions of electrical putting through, earthing connection and disconnecting. It is possible to install earthing deriving device outside the housing		
Sealing performance	After sealing according to the stipulated operation procedures, the injected air pressure is 100KPa±5Kpa, when immersed in clean water of normal temperature for 15 minutes, there should be no air bubbles, then observed for 24 hours, there should be no change of air pressure.		
Re-sealing performance	After reopening and resealing according to the stipulated operation procedures, the injected air pressure is 100KPa ± 5Kpa, when immersed in clean water of normal temperature for 15 minutes, there should be no air bubbles, then observed for 24 hours, there should be no change of air pressure.		
Pull	Bearing pull is $\geq 800N$ at axle orientation, there should be no breakage on the housing.		
Punching	Bearing pressure of 2000N/10cm for 1 minutes, there should be no breakage on the housing		
Impact	Bearing impact energy of 16N•m, 3 times of impacts there should be not breakage on the housing		





Bending	The spot between the FOSC and seal fitting can bear bending tension of 150N at bending angle of $\pm 45^{\circ}$ for 10 circles, there should be no breakage on the housing	At least 3 sets sampled each time	At least 3 sets sampled each time
Torsion	Bearing torsion 50N•m, 10 circle at torsion angle $\pm 90^{\circ}$. There should be no breakage on the housing.		
Temperature circle	Injected air pressure of 60KPa ± 5 KPa, the temperature circle ranging from $-40^{\circ}\text{C} \sim +65^{\circ}\text{C}$, 10 times of the circular tests (one circular consists of high temperature for 2 hours + indoor temperature for 2 hours + low temperature for 2 hours + indoor temperature for 2 hours) when the pressure declines, the amplitude is $\cong 5\text{Kpa}$, immerse the swatch in clean water of normal temperature for 15 minutes, there should be no air bubbles.		
Voltage resistance strength	After sealing the FOSC according to the stipulated operation procedures, immerse it in clean water of normal temperature in 1.5m depth for 24 hours, there should be no breakdown or arc over between the metallic components of the FOSC, between metallic components and the ground at DC 15KV for 1 minutes.		
Isolating resistance	After sealing the FOSC according to stipulated operation procedure, immerse it in clean water in 1.5m depth for 24h, the isolating resistance between the metallic components of the FOSC, between the metallic components and the ground should be $\cong 2 \times 10^4 \text{M}\Omega$.		

